

HomeScenario:
AIoT Smart Building Expert

homescenario

Smart home made easy!



- SIP/IP Intercom System
- Integrated Alarm, Access Control, Monitoring
- Cloud Service Platform
- Smart Home
- Energy Management

Integrated Smart Building Solution



IP Intercom Indoor Station

Video Door Bell

Outdoor Intercom Station



IP Intercom Management Console



RFID Access Controller

HomeScenario Business Scope Vertical Applications



Apartment
住宅大樓



Villa
別墅



Office
商業大樓



Hotel
旅館



School
學校



Meeting Room
會議室



Industry
工廠



Government
政府

HomeScenario: Cloud AIoT Solution Provider

- Home Automation
- Scenario Control

- Smart Metering
- Energy Management

- SIP/IP Intercom
- Access Control
- Alarm & Perimeter Protection
- Video Monitoring

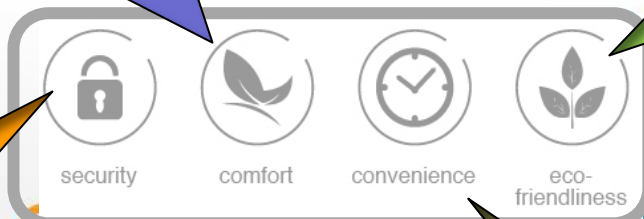

- Building Automation
- Concierge System
- Control *Anywhere*

Smart Home | Smart Building | Smart City

Smart Factory:
Architecture & Application

homescenario

Smart home made easy!

Demands for Smart Factory



- **Peace-of-mind:**
 - *Secure* (protecting people and assets, alarm notifications)
 - *Green* (energy saving, eco-friendly)
 - *Convenient* (ease-of-use, higher productivity)
 - *Comfort* (employee satisfaction, quality of working)
- **Unified Communication:**
 - Integrated intercom and telephone
 - Message and concierge service
- **Everything Under control:**
 - Lighting, dimming
 - Motorized curtain, shades, gates
 - HVAC, air-conditioner
 - Audio/video
 - Sensors, video monitoring
 - Smart and automatic scenario
- **Anytime, anywhere:**
 - Touch panel
 - iPhone/iPad/Android

Smart Factory IP Network Architecture

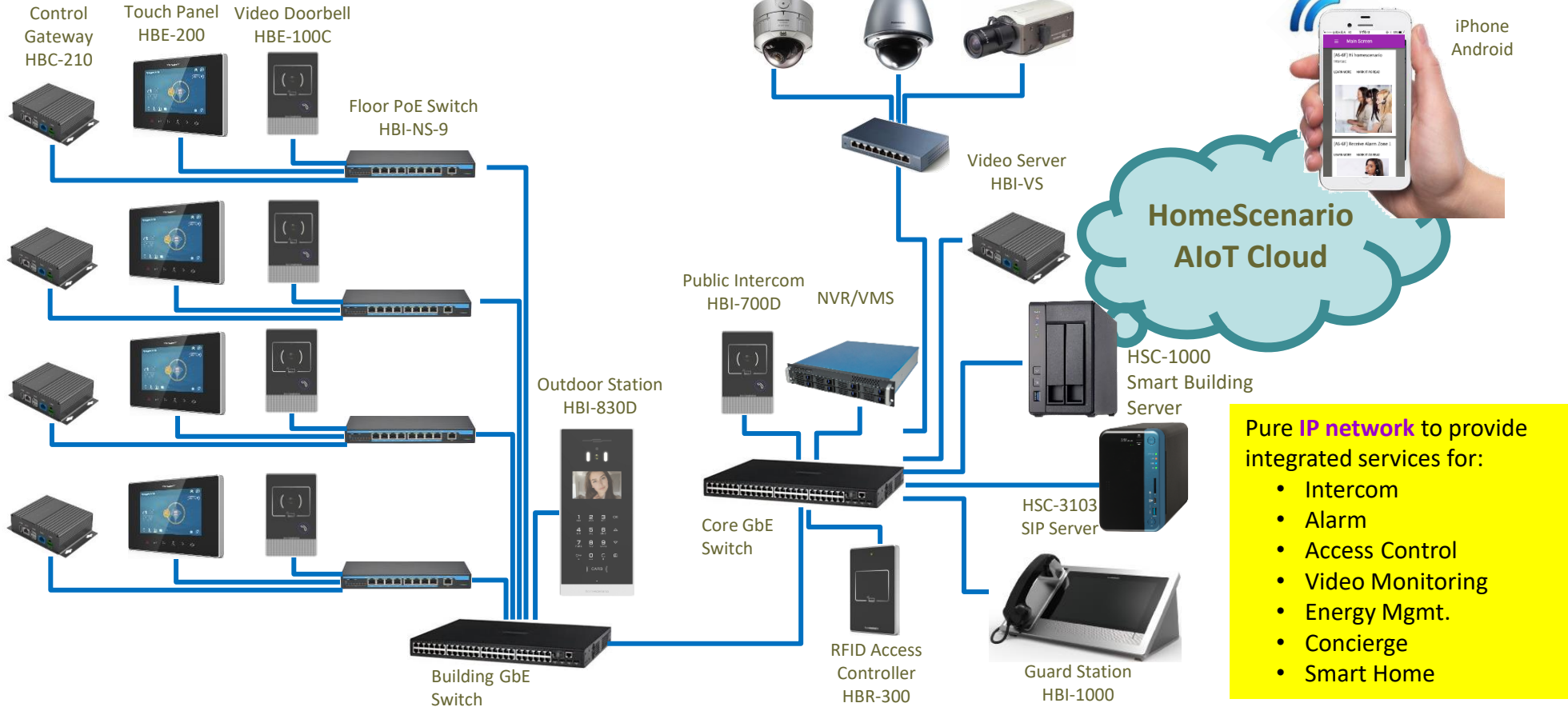

Pure IP network to provide integrated services for:

- Intercom
- Alarm
- Access Control
- Video Monitoring
- Energy Mgmt.
- Concierge
- Smart Home

The Factory Systems



- Systems to be properly integrated
- Unified control interface
- Controlled anywhere
- Collecting real-time information such as power metering, sensor status, video recording
- Auto send notification or trigger preset scenario

We Integrate and Make Smart Building Systems Work In Harmony

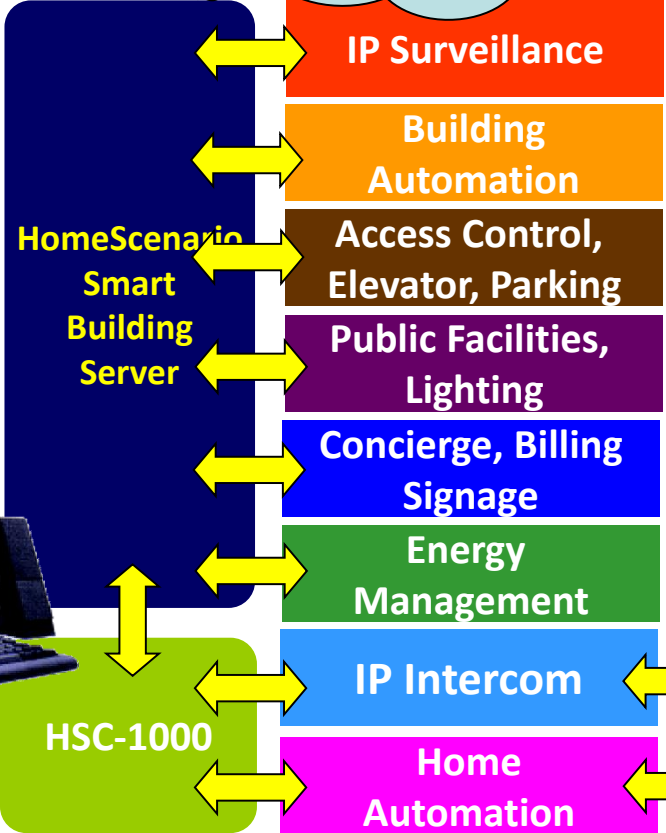
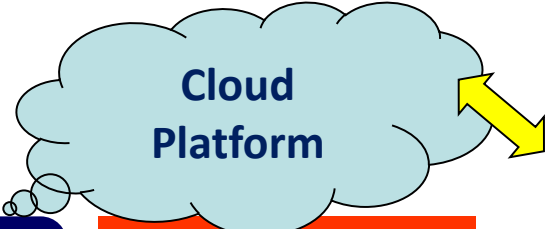

- Flexible architecture to facilitate 3rd party System Integration for smart building services
- Users to control and always get informed wherever they are!



User Interfaces

- *Multi-functional integration*
- *Fully customized scenarios and user interfaces*
- *Easy to deploy, wired and wireless*
- *Notified, monitor and control from anywhere*

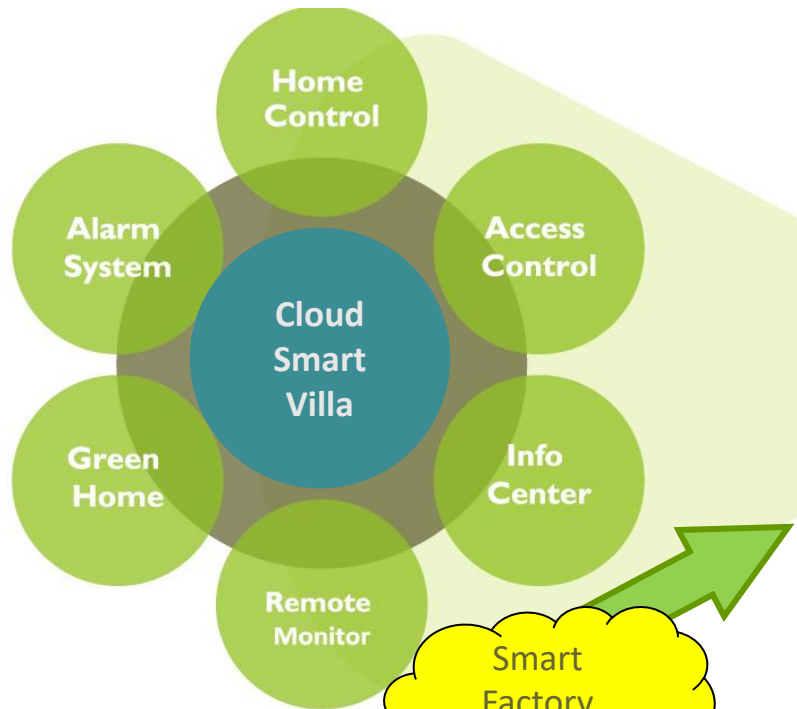

Smart AIoT Factory via LINE@



- App “without App”
- PUSH message upon alarm or service
- Multiple user registration for one Factory
- Features:
 - Alarm arm/disarm
 - Smart control
 - Call guard
 - Monitor video
 - Receive service information
 - Photo album
 - Access control
- Flexible Operation
 - Function button
 - Dialog flow
 - Web UI
 - Integration with 3rd party service

Smart Factory *Intercom* Applications

homescenario

Smart home made easy!

SIP-Based *Cloud Intercom*

(SIP Cloud Intercom)



Smart Factory *Alarm & Access*
Control Applications

homescenario

Smart home made easy!

Cloud Message Services

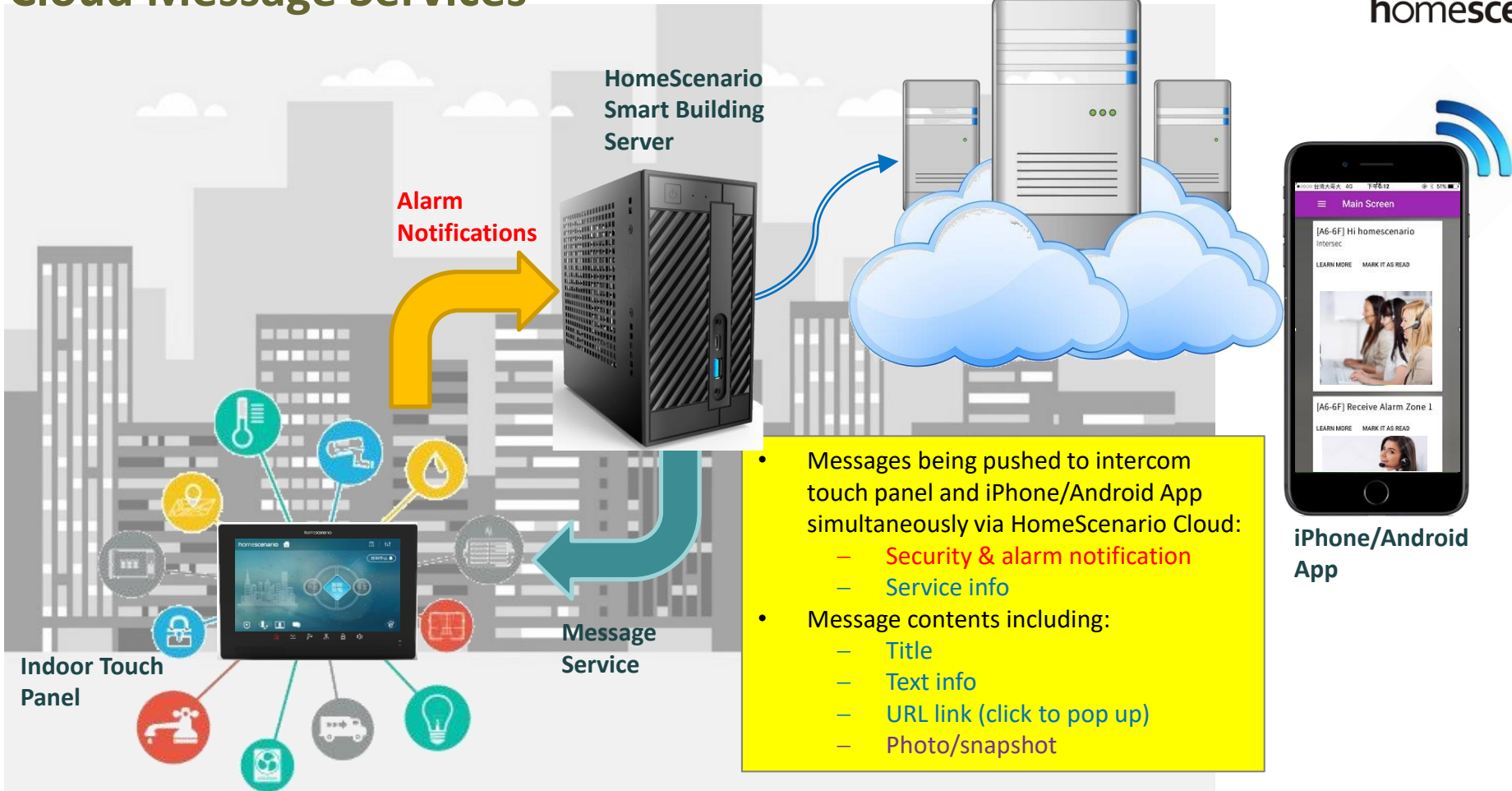

Alarm
Notifications

HomeScenario
Smart Building
Server

HomeScenario
Cloud Server

Indoor Touch
Panel

Message
Service

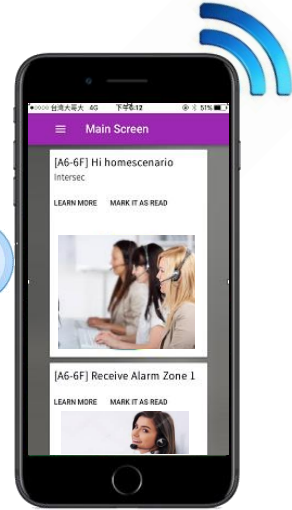

iPhone/Android
App

- Messages being pushed to intercom touch panel and iPhone/Android App simultaneously via HomeScenario Cloud:
 - Security & alarm notification
 - Service info
- Message contents including:
 - Title
 - Text info
 - URL link (click to pop up)
 - Photo/snapshot

Multiple Sensor Zone Protection



Intercom touch panel is also the *Alarm Control Panel*

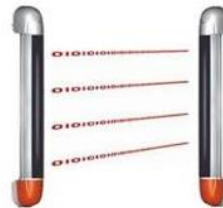
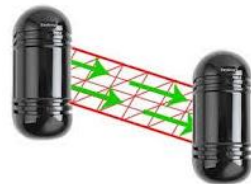

Multi Access Control:

RFID, QR Code, LPR, Face

User database and condition settings



HSC-1010W
Smart Building Server



Event Report



Database Sync



(LAN)



HBT-820D

IP Outdoor Station



HBE-700D

IP Public Intercom Station



HBR-300

IP Access Controller

- Via IP network, system supports various intercom stations and access controller
- Can be expanded to cover biometrics e.g. face recognition and fingerprint
- Each user can be granted with individual permission according to ID, time, condition, etc.
- System can be applied to door access, elevator control, parking etc.
- Server can update user database and synchronize to access controller; stored at equipment storage it can work online or offline



Door Access



Elevator Floor Control



Parking



Lobby Entrance

Advanced Access Control Integration



Face Recognition



Finger Print



QR Code



LPR



eTag

Parking Space Management

- Real-time parking space availability
- Traffic light guidance for parking entrance and pass way

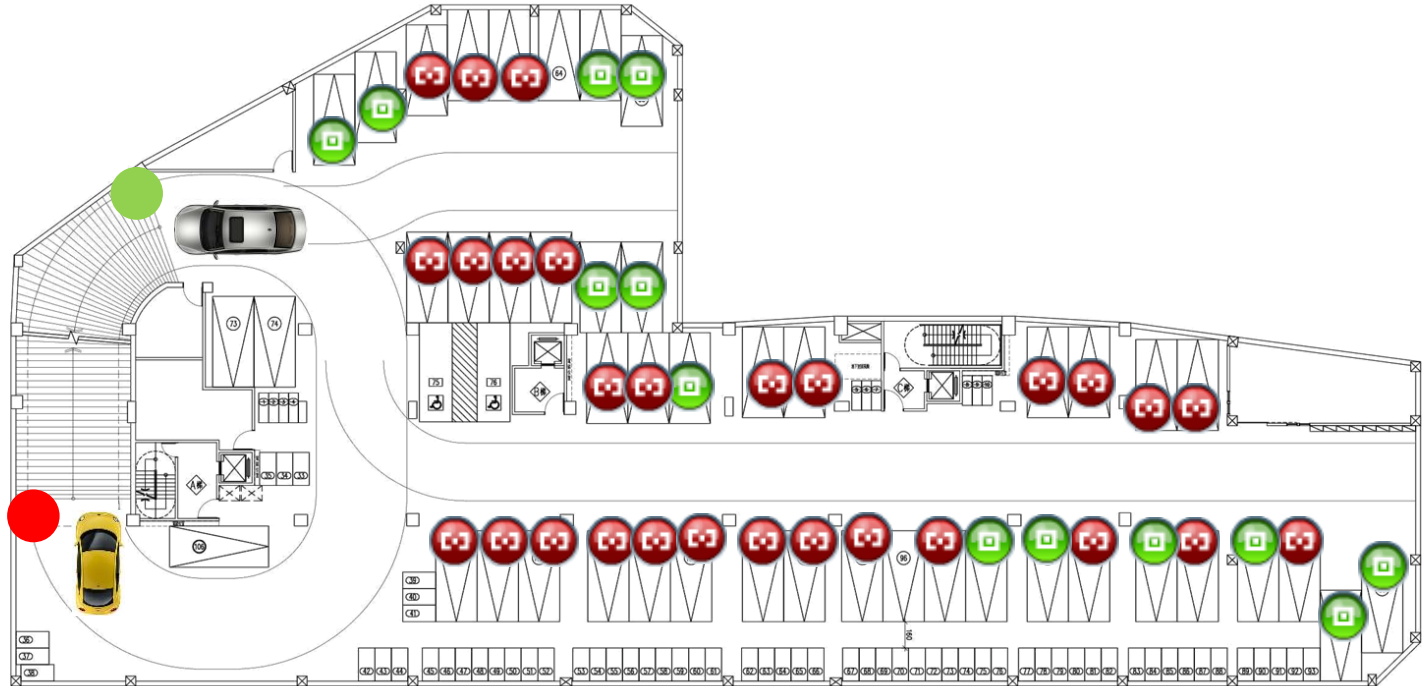

Parking Management System

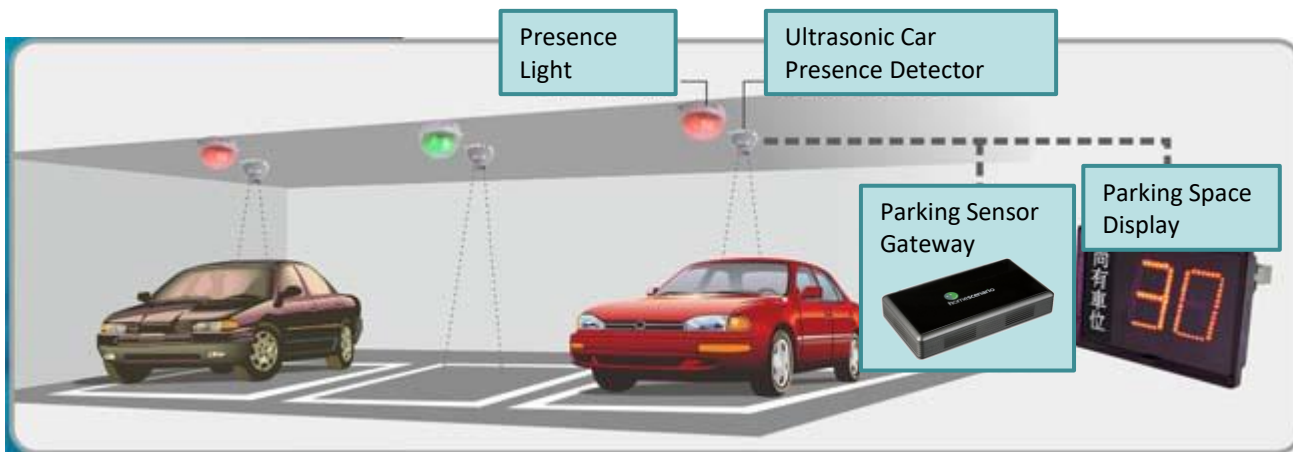

IR Beam Detector



Traffic Light



Parking Gate

Smart Factory *Automation*

homescenario

Smart home made easy!

IP Intercom + Smart Factory

Wired System for MDU/MTU



Wi-Fi/3G
RF

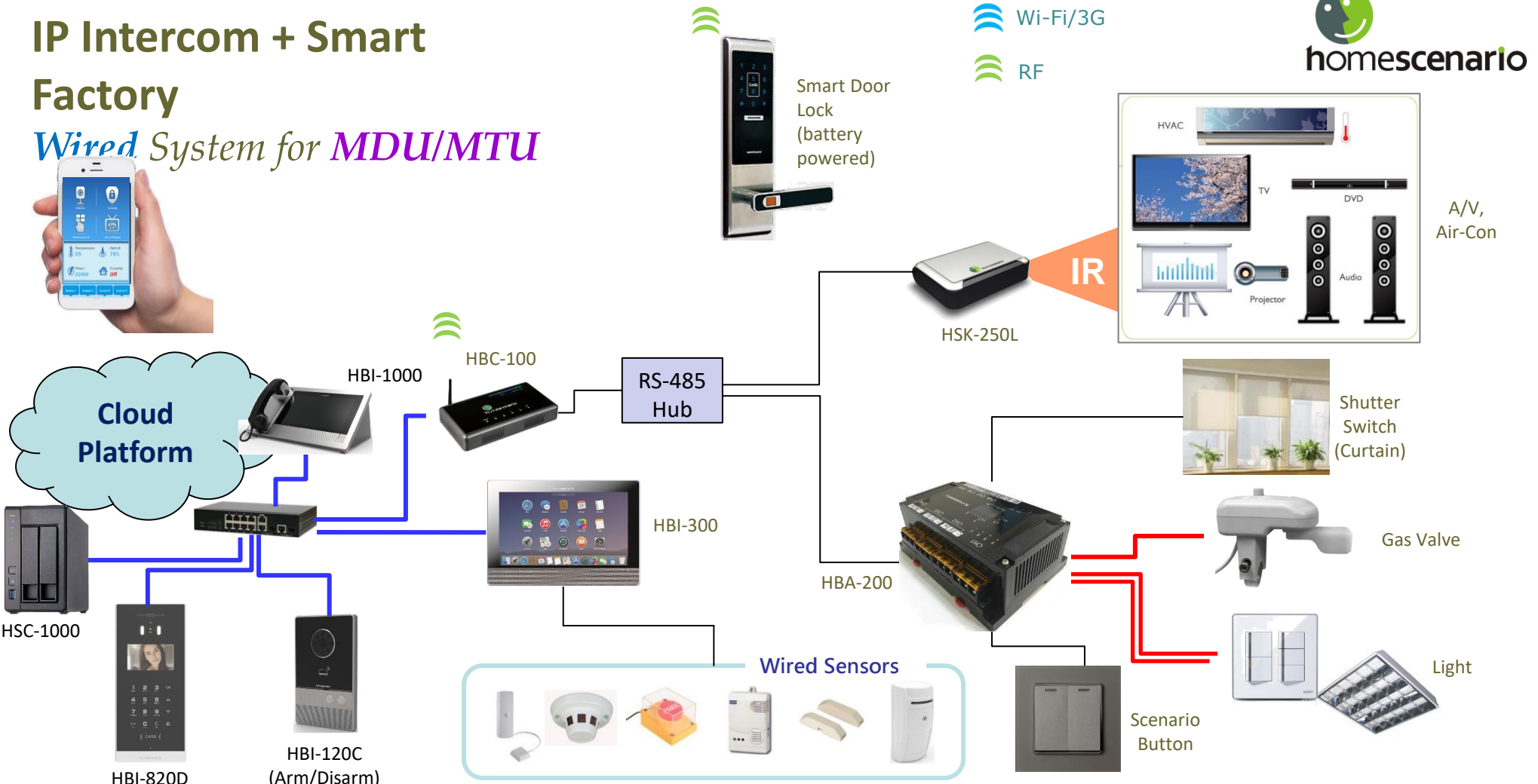

IP Intercom + Smart Factory

Wireless System for MDU/MTU



Wi-Fi/3G
RF

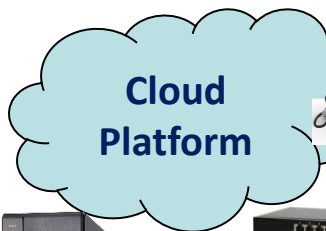

HBI-820D

HBI-120C
(Arm/Disarm)

Smart Meeting Room Scenario Example

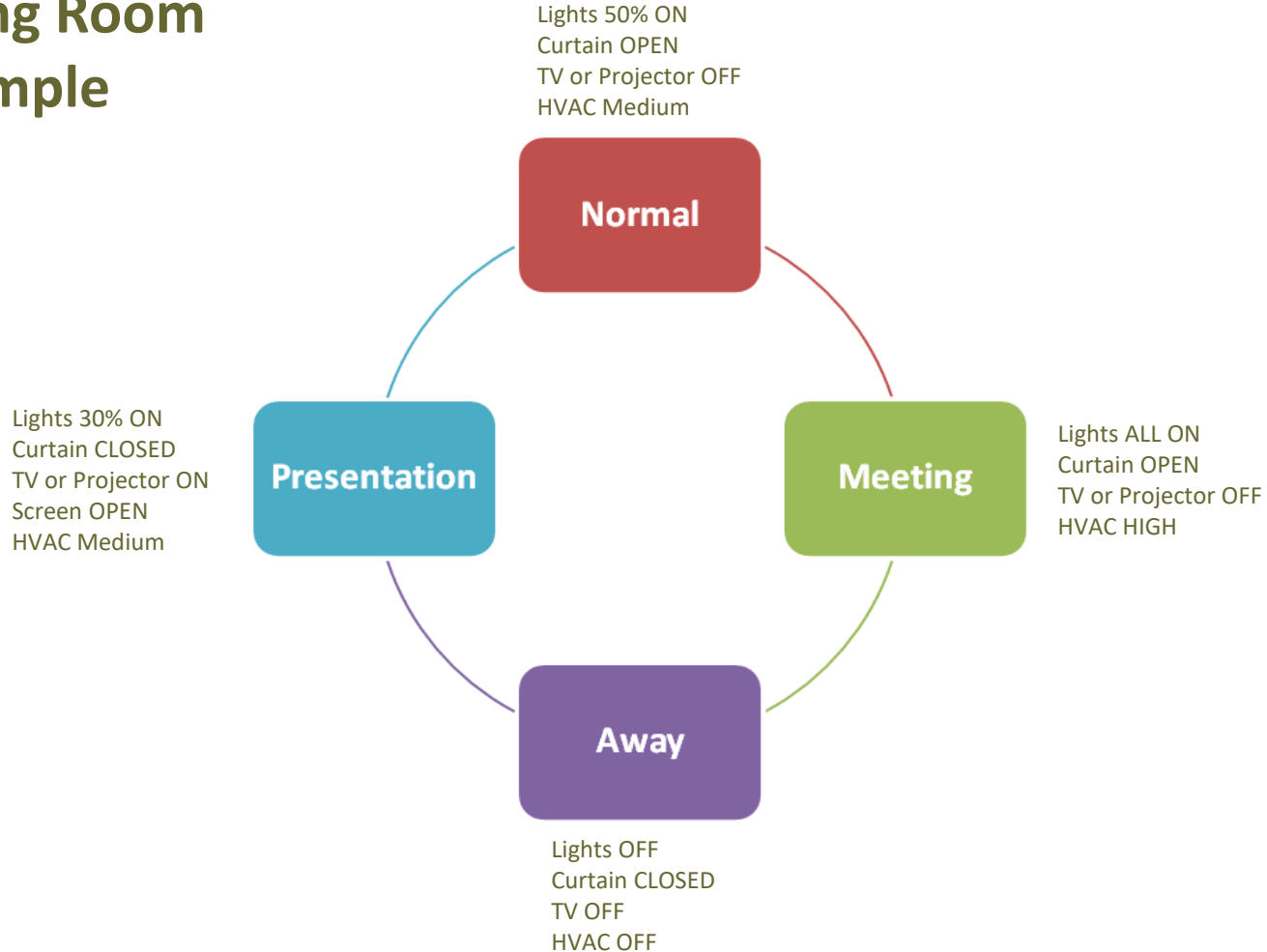

Smart Factory *Energy* *Management*

homescenario

Smart home made easy!

Building Blocks



- Power meter
- Water meter
- Gas meter
- Air quality e.g. PM 2.5
- Temperature & humidity
- Light luminance
- RPM, mileage
- etc.

- Statistics, charts, comparison tables, histograms
- 24x7 pricing table
- Policies, benchmarks, conditions
- Automation, control, scenario activation
- etc.

- User-based accounting system
- Prepayments/receivables, wallet balance
- Cloud back-up
- Cloud message notification
- etc.

Application Diagram

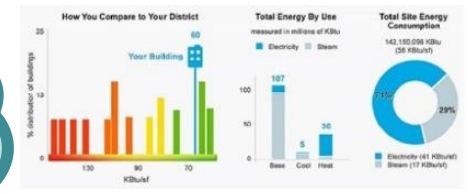
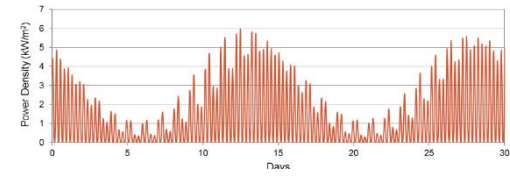
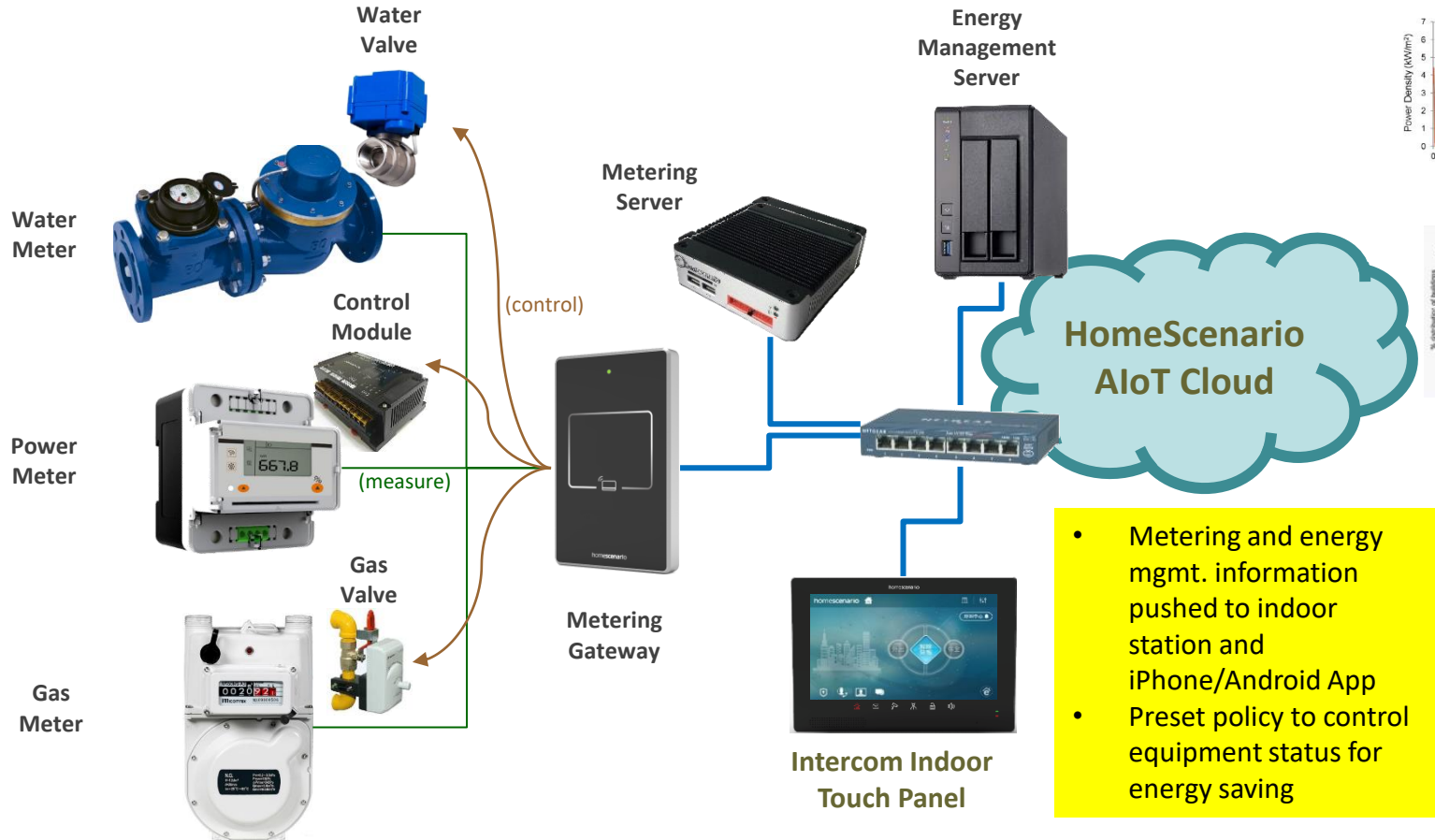

iPhone/Android App

Application Introduction



homescenario

- **Real-time smart metering & display, e.g.:**
 - Power meter
 - Water meter
 - Gas meter
- **Energy consumption statistics:**
 - Histogram (daily, weekly, monthly) for whole building or selected units/zones
 - Average, ranking, etc.
- **Cost calculations according to 24x7 pricing table**
- **Billing and prepayment system**
- **Cloud-based push message service**
- **Smart control:**
 - Lighting on/off/dim
 - Air-conditioner
 - Water valve
 - Gas valve
- **Integrated user interfaces:**
 - PC monitor in management Factory
 - Touch panel in each room/zone
 - iPhone/Android App

Smart Factory Feature Summary

homescenario

Smart home made easy!

Integrated Features

- **SIP/IP Intercom:**
 - Indoor station vs. outdoor video phone
 - Indoor station vs. video doorbell
 - Door to door intercom
 - Call mgmt. center operator
 - Forward incoming call to *iPhone/Android anywhere*
- **Access Control:**
 - Indoor station or mgmt. console to unlock door during intercom
 - Centralized management access control via *Mifare RFID*
 - *Elevator* floor access control, call elevator
- **Alarm System:**
 - System arm/disarm
 - Instant alert to mgmt. center
 - Instant siren alert
 - (Optional) Instant alert to homeowner via e-mail/SMS or *iPhone/Android* pushed message

Integrated Features (cont'd)

- **Information Feeds:**

- Publish news/alerts/announcements from mgmt. center, to ALL or SELECTED *indoor touch panel or iPhone/Android*
- Updated temperature, weather conditions, etc.

- **Smart Home Automation:**

- Home controls:
 - Lighting on/off/dim
 - Appliance on/off
 - Window shades
 - Thermostats
 - Audio/video
- *Scenario* control; one touch does it all
- Control via indoor station, *iPhone/iPad/Android*

- **Control *Anywhere*:**

- Via *3G/4G, Wi-Fi or internet*
- SMS/email notification
- Camera video monitoring

Integrated Features (cont'd)

● Energy Management:

- Always collects energy consumption values via digital meters such as *Power, Water, Gas*
- Reports energy metering information:
 - *Real-time* energy consumption
 - *Histogram* chart (daily, weekly, monthly etc.)
 - *Comparison* table
 - Others
- Sets benchmark value and sends *alert* notification if real-time value over benchmark
- *Controls* equipment or appliance to reduce energy consumption, e.g.:
 - Lighting
 - Air-conditioner
 - Gas valve
 - Water valve/pump
 - Etc.
- Prepares *billing and accounting*:
 - Prepayment
 - Balance check and notification

Main Products

homescenario

Smart home made easy!

IP Video Doorbell



HBE-100C

Features	Technical Spec
<ul style="list-style-type: none">• Wide angle, high quality CMOS camera• Elegant industrial design with painted ABS frame and tempered glass front panel; which can well fit various interior design styles• Wall-mount 1-gang installation, slim outlook thickness• Supports IP network, works with HBE-200/310 indoor stations• LED illumination during intercom for night vision• Automatic snapshot during intercom for further verifications• Indoor station can monitor camera video from HBE-100C• Embedded RFID reader for controlling door lock or security alarm arm/disarm	<ul style="list-style-type: none">• Power 12-24V DC• Camera CMOS wide angle• Op. Power 4.5W• Standby 0.5W• RFID Mifare 13.56MHz• Network RJ-45 Ethernet• I/O Lock/Open• Installation 1-Gang• Protection Indoor/Outdoor• Materials Painted ABS frame, with glass-type front panel

10.1" IP Indoor Station



HBE-200 (7")



HBE-310 (10.1")

Features	Technical Spec
<ul style="list-style-type: none"> • 7" or 10.1" LCD with capacitive touch panel • Elegant, slim industrial design with painted ABS frame and tempered glass front panel • Integrated features: alarm (8 zones), intercom, monitoring, message service, home automation • Integrated access control such as door lock, elevator floor control • Video intercom with video doorbell, outdoor intercom station, intercom console, and other indoor stations in the same network • Monitors video from video doorbell, outdoor station, CCTV/DVR or IP camera (via HBI-VS) • Displays information messages • Home automation user interfaces for controlling lighting, thermostats, window shades, audio/video, etc. 	<ul style="list-style-type: none"> • Power 12-24V DC • Display 7" or 10.1" TFT LCD • Touch Panel Capacitive • Network RJ-45 Ethernet • Alarm Input 8 zones • Siren Output 1x (optional) • Serial RS-485 (optional) • Installation Wall-mount • Protection Indoor • Materials Painted ABS frame, tempered glass front panel

Smart Home Control Gateway



HBC-100

Features	Technical Spec
<ul style="list-style-type: none">• Can expand RS-485 for wired smart home control• Also supports Z-Wave 2-way mesh networking, RF range up to 30m indoors• Provides digital input/output connections• Controls various home systems, e.g. light switch, thermostat, door access, window shades, security monitoring, A/V equipment, as well as scenarios• Controls via iPhone/iPad/Android/intercom touch panel• Always updates system status and allows controlling from anywhere via HomeScenario AIoT Cloud Platform• Works with central management server for large scale deployment with HomeScenario Smart Building System	<ul style="list-style-type: none">• Power 12V DC• LAN RJ-45 Ethernet• Wireless Wi-Fi/Z-Wave• Installation Desktop• DI 4x• DO 1x• Serial RS-485 (USB)• Program Button for device program/association and factory reset

Smart Home I/O Module



HBA-200/210

Features	Technical Spec
<ul style="list-style-type: none">• Supports RS-485/Modbus for wired smart home control• Provides 8 NC/NO relay outputs with high rating, which can be used to control lighting on/off or window curtain• Can be used to switch load of AC or DC• Max loading (each load): Resistive 20A x4, 10A x4• Also provides 8-channel digital inputs, which can be connected with sensor or scenario button• DIN-Rail installation	<ul style="list-style-type: none">• Serial RS-485• Digital Input 8x digital inputs, terminal blocks• Relay Output 4x 20A, 4x 10A COM/NC/NO; terminal blocks• N Neutral wire, for power status detection• Installation DIN-Rail• Dimension 155x110x60mm

IR Control Station



HSK-250Z

Features	Technical Spec
<ul style="list-style-type: none"> • Receives commands from gateway and transmits IR signals, either by internal IR transmitter, or IR emitter cable (HSK-10) • Embedded with IR database for A/V system • Supports IR code learning for A/V and HVAC systems • RiteON™ technology which auto detects equipment on/off status by connecting with the power detector, so as to assign the exactly correct IR command pre-defined by scenario • When acting as a host controller, arranges scenarios for lighting, AV system, projector screen, window shades, thermostat • Supports RS-485 for connecting with host controller • You can use iPhone/iPad/Android or IP intercom touch panel to easily control, from anywhere 	<ul style="list-style-type: none"> • Power 12V DC • Connection Z-Wave • Frequency 32-500KHz • IR Blaster IR LEDs for 270° transmission, 5m range • IR Cable Via 3.5mm phone jack

Guard Station



HBI-1100 (10.1")

IR Control Station



HSK-250Z

Features	Technical Spec
<ul style="list-style-type: none"> • Receives commands from gateway and transmits IR signals, either by internal IR transmitter, or IR emitter cable (HSK-10) • Embedded with IR database for A/V system • Supports IR code learning for A/V and HVAC systems • RiteON™ technology which auto detects equipment on/off status by connecting with the power detector, so as to assign the exactly correct IR command pre-defined by scenario • When acting as a host controller, arranges scenarios for lighting, AV system, projector screen, window shades, thermostat • Supports RS-485 for connecting with host controller • You can use iPhone/iPad/Android or IP intercom touch panel to easily control, from anywhere 	<ul style="list-style-type: none"> • Power 12V DC • Connection RS-485 • Frequency 32-500KHz • IR Blaster IR LEDs for 270° transmission, 5m range • IR Cable Via 3.5mm phone jack

Wiring & Installation

homescenario

Smart home made easy!

Indoor Station

Step 1



Step 2

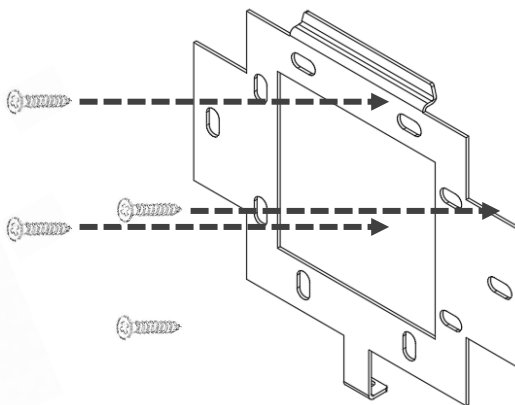

Step 3

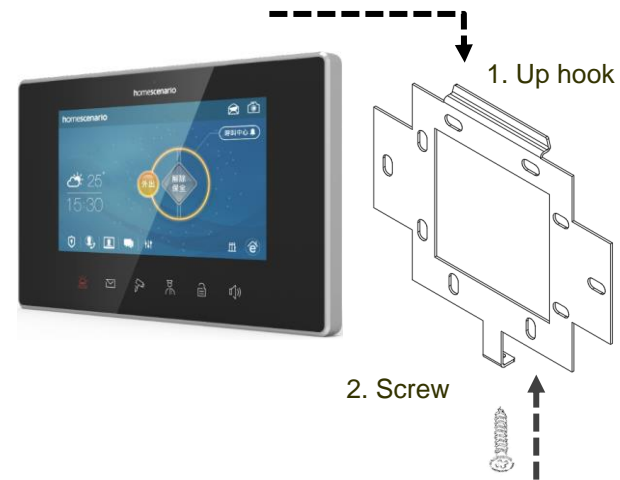

Alarm Zones

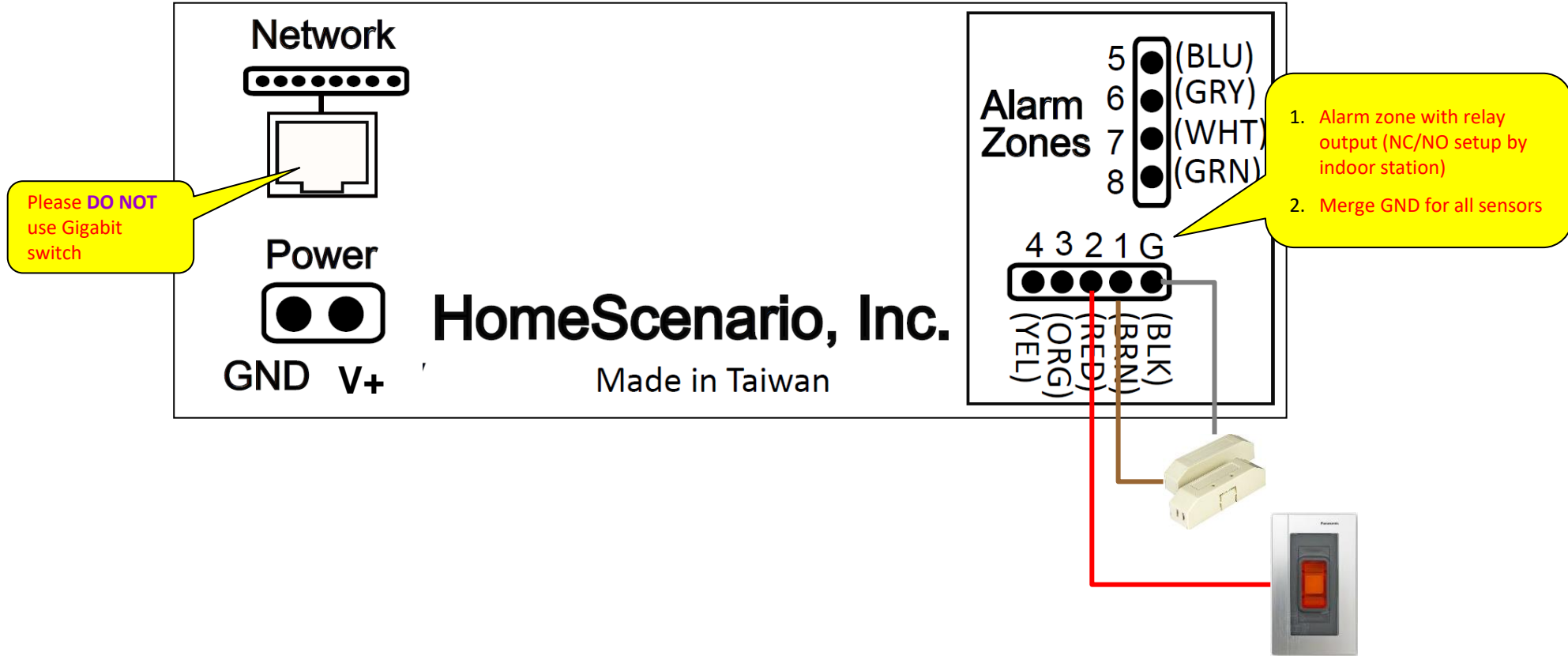

Video Doorbell

Mounting Frame

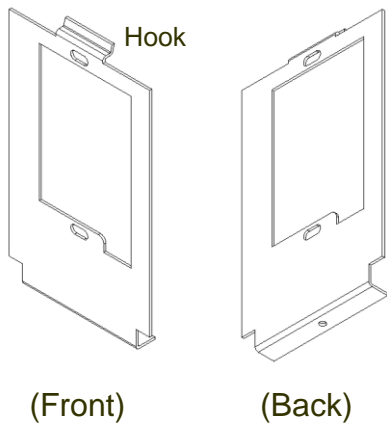

Step 1

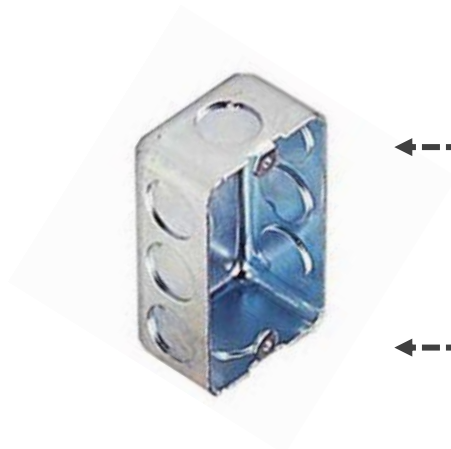

Step 2

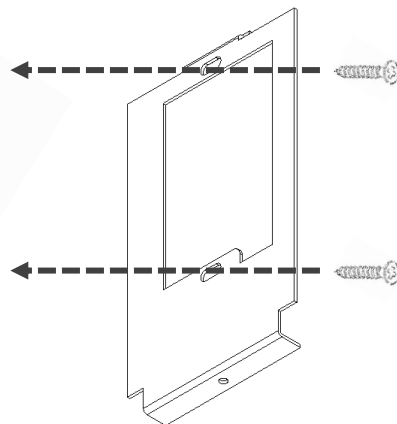

Step 3

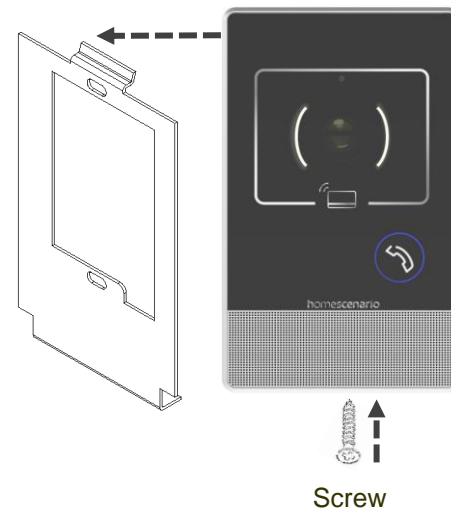

HBA-200 Lighting Wiring

3-Way Wiring

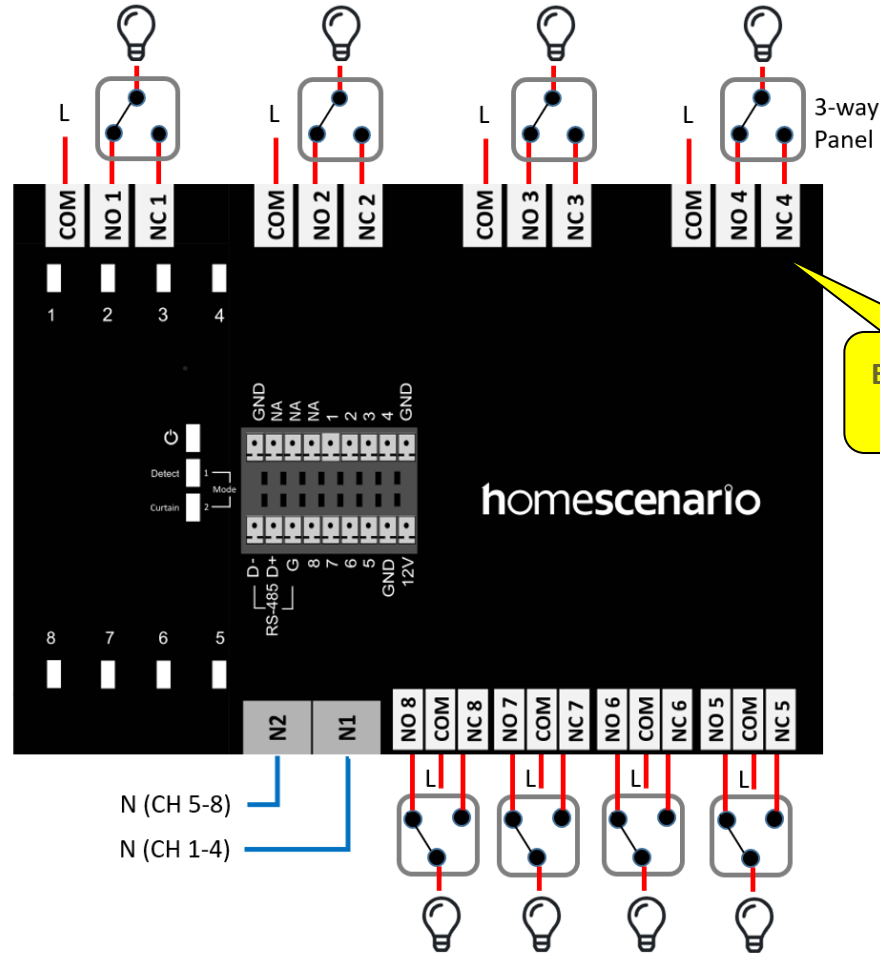
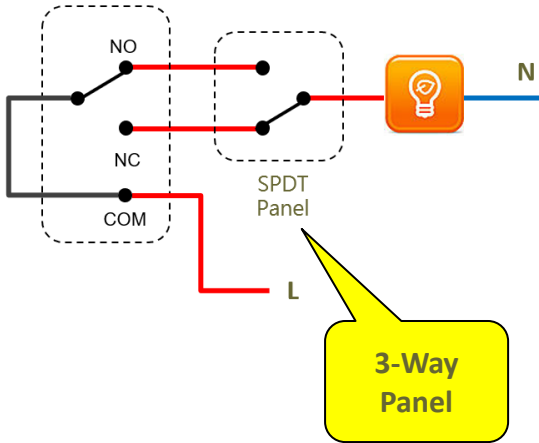

HBA-210 Curtain Wiring

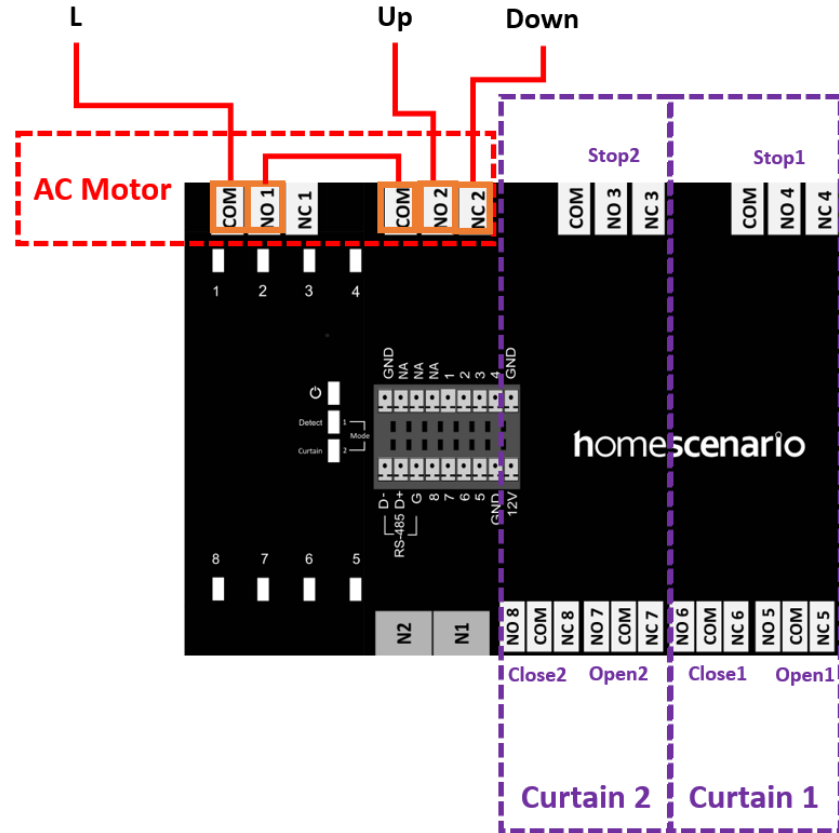

Window Shades Control (HSM-300Z)

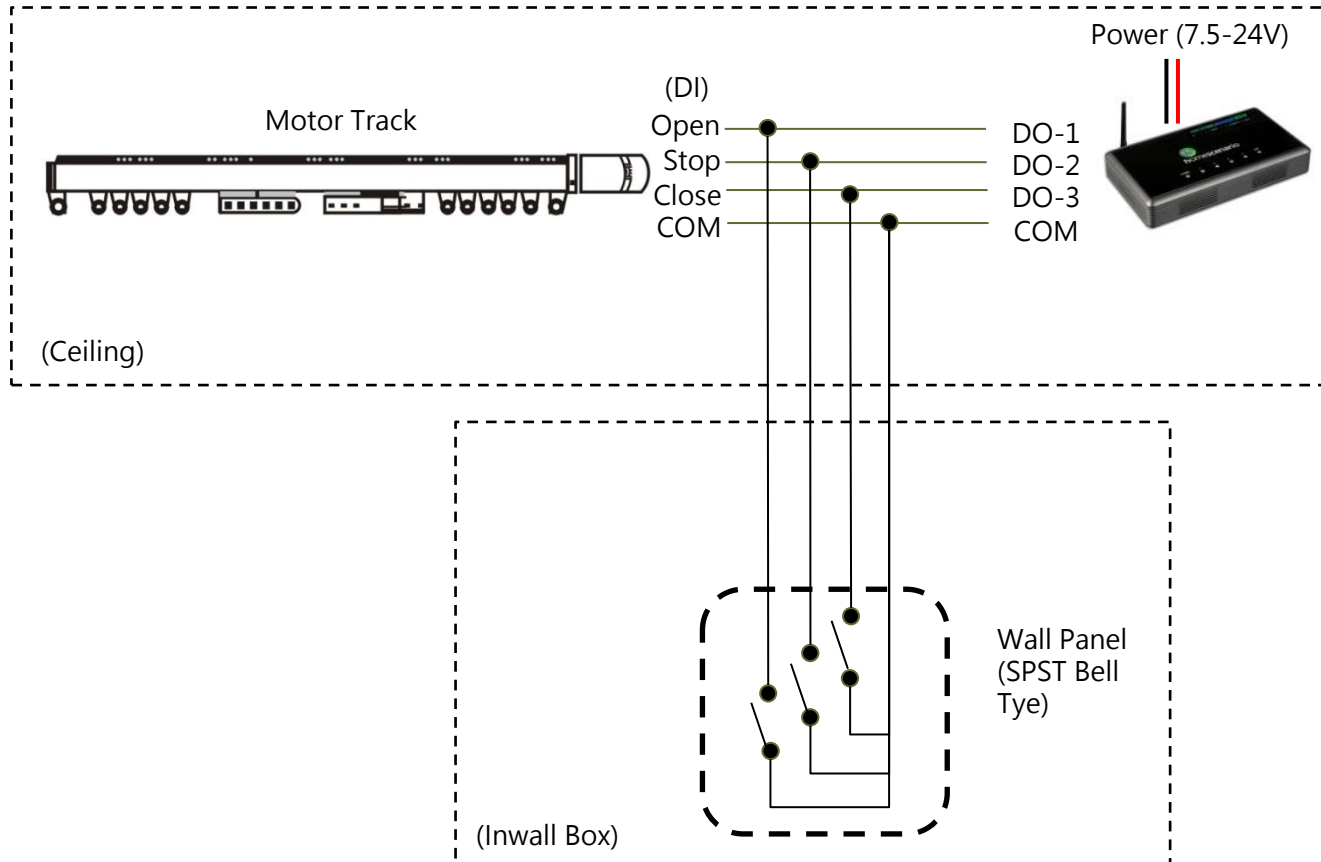

Wiring Instruction:

Window Curtain

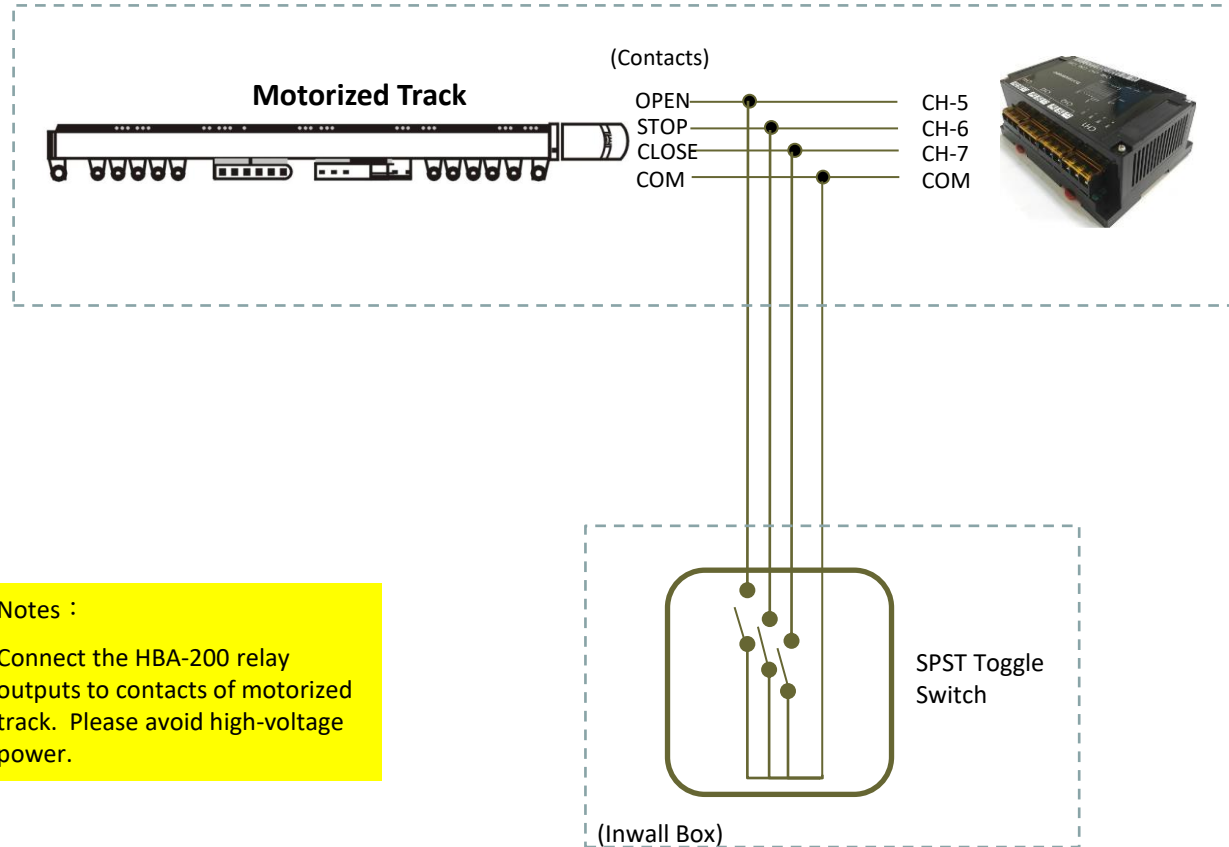

Notes :

Connect the HBA-200 relay outputs to contacts of motorized track. Please avoid high-voltage power.

Our Leadership

homescenario

Smart home made easy!

Adaptive User Interface

Flexible UI and scenario design

	Normal		Reading		Camera
	Home Theater		Music		Temperature
	Dining		Disarm		Humidity
	Sleeping		Arm		Sensor Status
	Wake-Up		Away		Power Consumption

Why HomeScenario?

HunterDouglas



BANG & OLUFSEN



SONY



PHILIPS

Let's make things better

海康威视

HIKVISION

legrand

bticino

Panasonic

somfy.



tyco
Security Products

B&W

SAMSUNG

DAIKIN

Honeywell

1. Well integrated with **No. 1** brands in the world

2. Customized **User Interfaces** for **Controlling from Anywhere**

3. Tailor-made **Scenarios** to meet user requirements

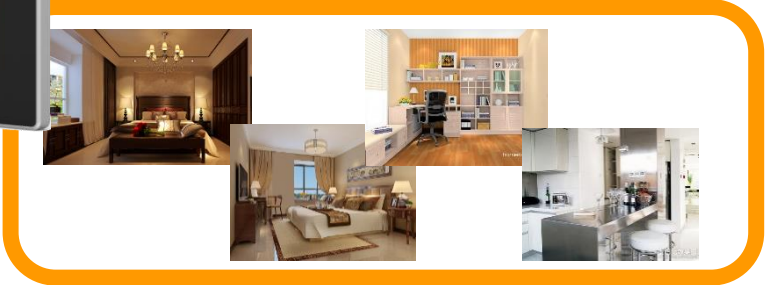

Comfort

Safety

Green

Convenience

HomeScenario Solution Advantage

- Flexible, scalable, powerful
- Well integrated *smart building* solution: *IP intercom, alarm, access control, surveillance, home automation*
- *Cloud-based*, can be accessed and controlled *from anywhere* via the Internet
- *Wired & wireless* control technologies, flexible installation per project requirements
- Open architecture for cloud system, easy to *integrate* value-added services/systems and *maintain*

HomeScenario Vision



Asia's Leading Provider for Smart Building System



Thank You

joel_liu@homescenario.com

homescenario

Smart home made easy!

www.homescenario.com